

# Safety Relay G7S

## Safety Relay conforming to EN standard

- Conforms to EN50205.
- A minimum of 0.5 mm between contacts even when one contact is welded. (prEN50205 Class A)
- Forcibly guided contacts.
- The G7S contributes to the protection of machinery when used as part of an interlocking circuit.
- Most suitable for safety circuits in press machinery, machine tools, and other production machinery.
- Track-mounting and Back-mounting Sockets are available.

Note: Be sure to refer to the page G-342.

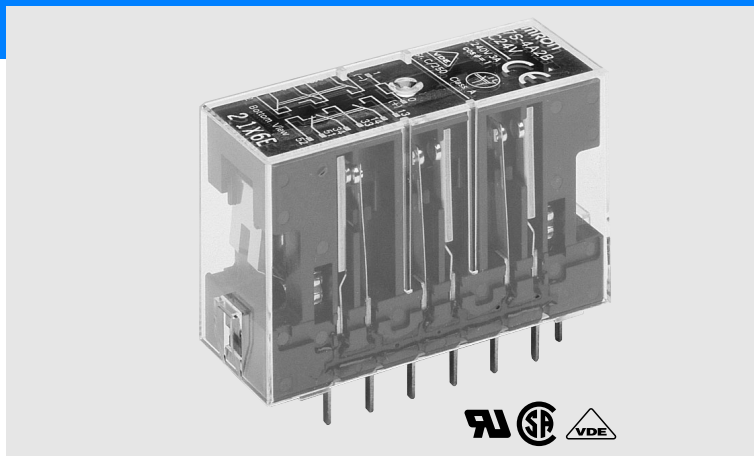

## Ordering Information

### Model Number Legend

G7S- $\square$ A $\square$ B  
1 2

#### 1. NO Contact Poles

- 4: 4PST-NO
- 3: 3PST-NO

#### 2. NC Contact Poles

- 2: DPST-NC
- 3: 3PST-NC

### Safety Relays

Type	Poles	Contact form	Rated voltage (V)	Model
Standard	6 poles	4PST-NO, DPST-NC	24 VDC	G7S-4A2B
		3PST-NO, 3PST-NC		G7S-3A3B

### Accessories

#### Safety Relay Sockets

Type	Model
Track-mounting	Common for track mounting and screw mounting P7S-14F
Back-mounting	Solder terminals P7S-14A
	PCB terminals P7S-14P

#### Socket Mounting Plate

Applicable Socket	Quantity	Model
P7S-14A	10	P7A-A10

#### Relay Removal Tool

Applicable Socket	Model
P7S-14F P7S-14A P7S-14P	P7S-B

## Specifications

### Ratings

#### Operation Coil

Rated voltage	Rated current	Coil resistance	Must operate voltage	Must release voltage	Max. voltage	Power consumption
24 VDC	30 mA	800 Ω	80% max. (V)	10% min. (V)	1110% (V)	Approx. 0.8 W

Note: 1. The rated current and coil resistance are measured at a coil temperature of 23°C with tolerances of ±15%.  
 2. Performance characteristics are based on a coil temperature of 23°C.  
 3. The maximum voltage is based on an ambient operating temperature of 23°C maximum.

#### Switching Section (Contact Ratings)

Load	Resistive load (cos φ =1)	Inductive load (cos φ = 0.4, L/R = 7 ms)
Rated load	240 VAC: 3 A, 24 VDC: 3 A	240 VAC: 3 A, 24 VDC: 1 A
Rated carry current	6 A	
Maximum switching voltage	250 VAC, 24 VDC	
Maximum switching current	6 A	
Maximum switching capacity (reference value)	1,440 VA, 144 W	
Min. permissible load (See note.)	5 VDC, 10 mA	
Contact material	Ag ) Au	

Note: The above values are based on an operating frequency of 60 operations/min.

### Characteristics

Contact resistance (See note 2.)	100 mΩ max.	
Operate time (See note 3.)	50 ms max.	
Release time (See note 3.)	50 ms max.	
Maximum operating frequency	Mechanical	18,000 operations/hr
	Rated load	1,800 operations/hr
Insulation resistance	100 MΩ min. (at 500 VDC)	
Dielectric strength	2,500 VAC, 50/60 Hz for 1 min (1,500 VAC between contacts of same polarity)	
Vibration	Destruction	10 to 55 Hz, 1.5–mm double amplitude
	Malfuction	10 to 55 Hz, 0.75–mm double amplitude
Shock	Destruction	1,000 m/s <sup>2</sup> (approx. 100G)
	Malfuction	100 m/s <sup>2</sup> (approx. 10G)
Life expectancy	Mechanical	10,000,000 operations min. (at approx. 18,000 operations/hr)
	Electrical	100,000 operations min. (at the rated load and approx. 1,800 operations/hr)
Ambient operating temperature	-10°C to 70°C (no icing)	
Ambient operating humidity	35% to 85% RH	
Ambient storage temperature	-25°C to 70°C (no icing)	
Ambient storage humidity	35% to 85% RH	
Weight	Approx. 65 g	

Note: 1. The values given above are initial values.  
 Note: 2. Measurement conditions: 5 VDC, 10 mA, voltage drops.  
 Note: 3. Measurement conditions: Rated voltage operation  
 Ambient operating temperature: 23°C  
 Does not include bounce time.

### Characteristics of Safety Relay Socket

Model	Continuous current	Dielectric strength	Insulation resistance
P7S-14□	6 A	2000 VAC for 1 min. between terminals	1000MΩ min (see note)

Note: Measurement conditions: Measurement of the same points as for the dielectric strength at 500 VDC.

## Approved Standards

VDE0435 (Electrical Relays); Approved by VDE  
 IEC255 (Electrical Relays); Approved by VDE  
 EN50205 (Electrical Relays); Approved by VDE  
 UL508 (Industrial Control Device)  
 CSA22.2 No.14 (Industrial Control Device)

## Engineering Data

Life Expectancy (240 VAC;  $\cos\phi=0.4$ ,  $\cos\phi=1$ )

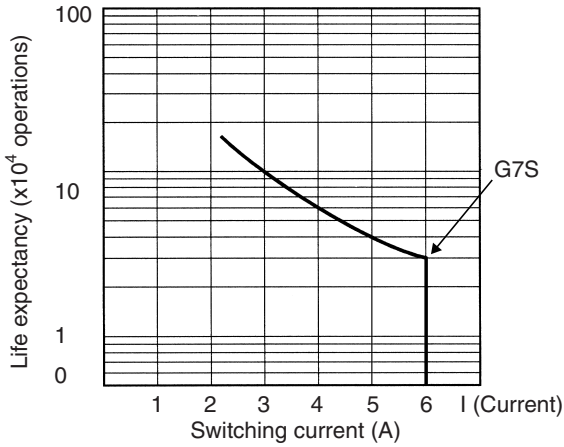

### Life Expectancy (AC15, DC13 IEC947-5-1/Table 4)

6,050 operations min. (AC15, 240 VAC, 3 A,  $\cos\phi=0.3$ )  
 6,050 operations min. (DC13, 24 VDC, 1 A, L/R 100 ms)  
 VDE approved.

## Dimension

Note: All units are in millimeters unless otherwise indicated.

### Safety Relays

G7S-4A2B

G7S-3A3B

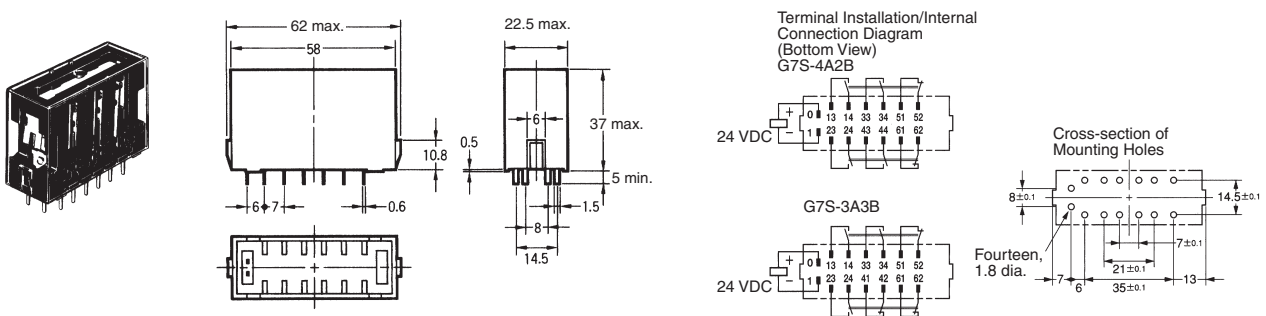

Safety Relay Sockets  
 P7S-14F Track-mounting Socket

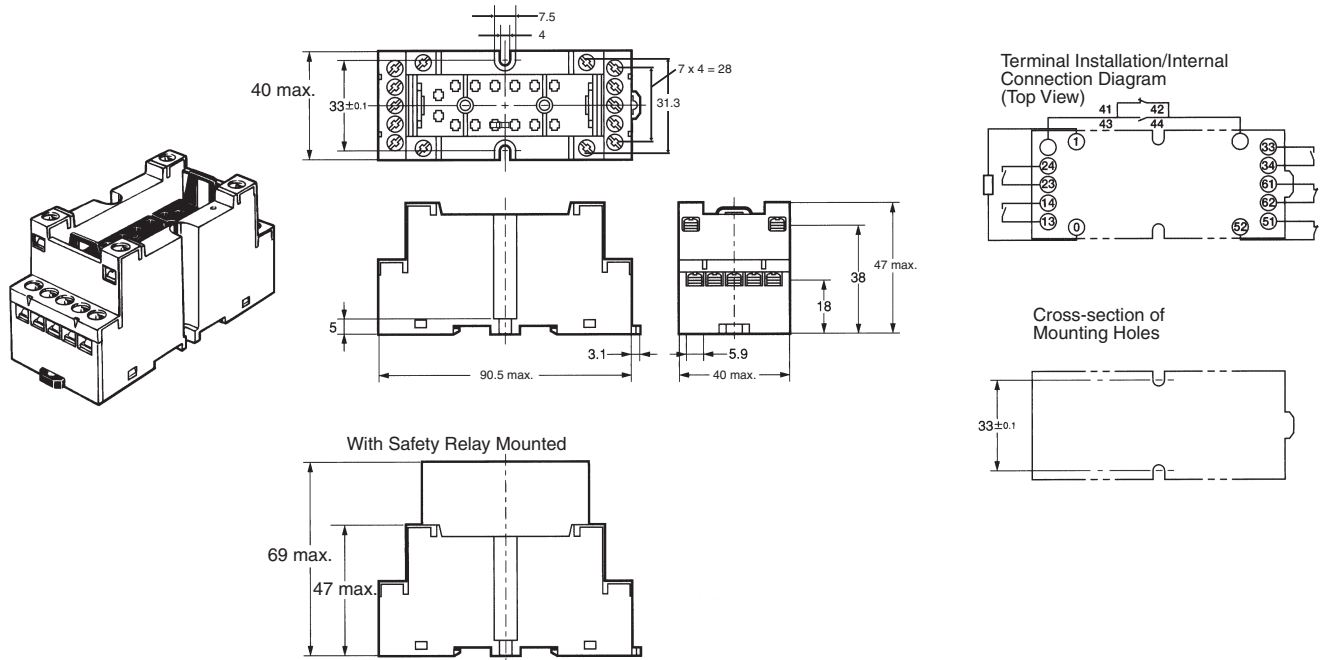

P7S-14A Back-mounting Socket  
 (Solder Terminals)

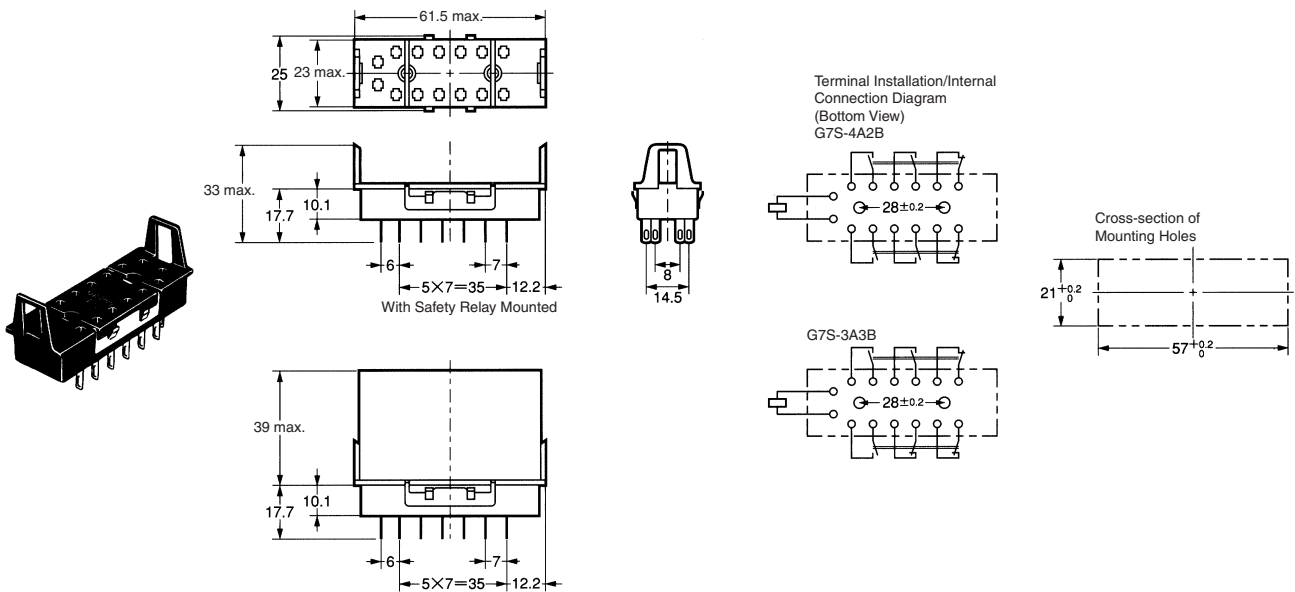

P7S-14P Back-mounting Socket (PCB Terminals)

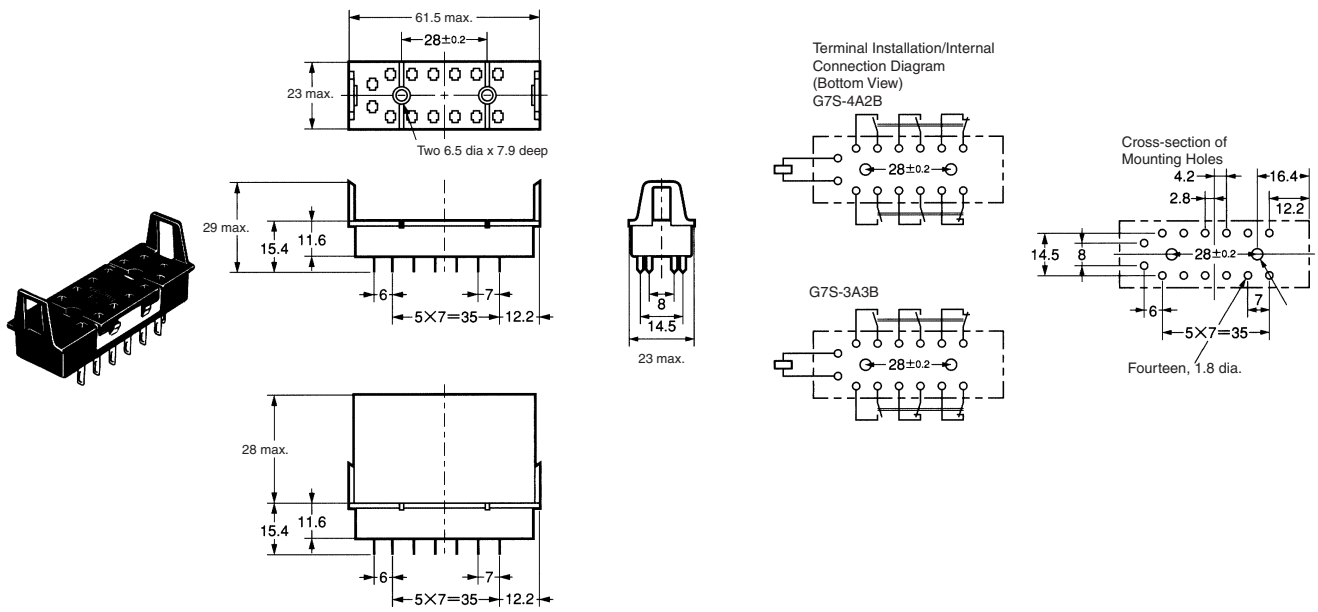

Socket Mounting Plate

P7S-A10 (Special Mounting Plate for P7S-14A)

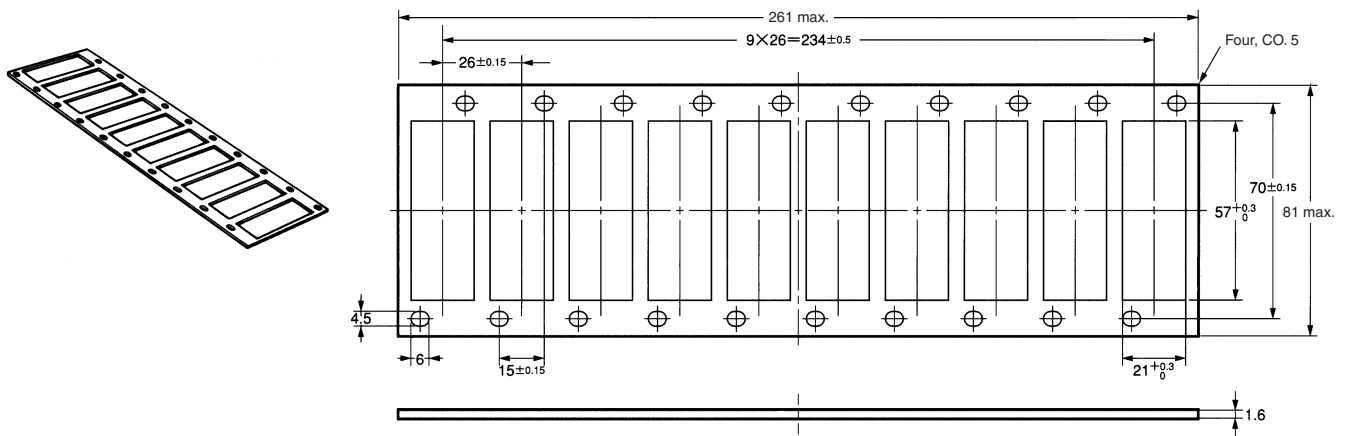

Relay Removal Tool

P7S-B

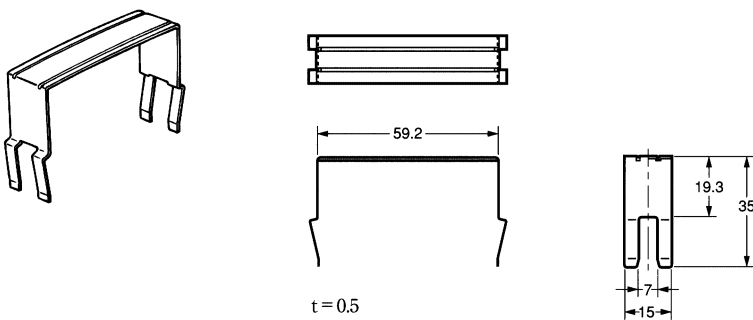

## Precautions

---

### Forcibly Guided Contacts

When NO contacts are welded, the coil will be non-energized so all NC contacts will maintain a distance between the contacts of 0.5 mm minimum. Likewise if NC contacts are welded, the coil will be energized so all contacts will maintain between each other of 0.5 mm minimum.

### Application

Do not touch the terminal area of the Relays or the socket terminal area (changed area) while power is ON. Electric shock will result.

### Safety Relays

A Safety Relay is a Relay with which a safety circuit can be configured. For common precautions when using and handling Relays, refer to OMRON's Relay Catalog.

### Contacts

The coil terminals have polarity (positive and negative). Operation is not possible if there are connected in reverse.

ALL DIMENSIONS SHOWN ARE IN MILLIMETERS.

To convert millimeters into inches, multiply by 0.03937. To convert grams into ounces, multiply by 0.03527.